

AC

DC

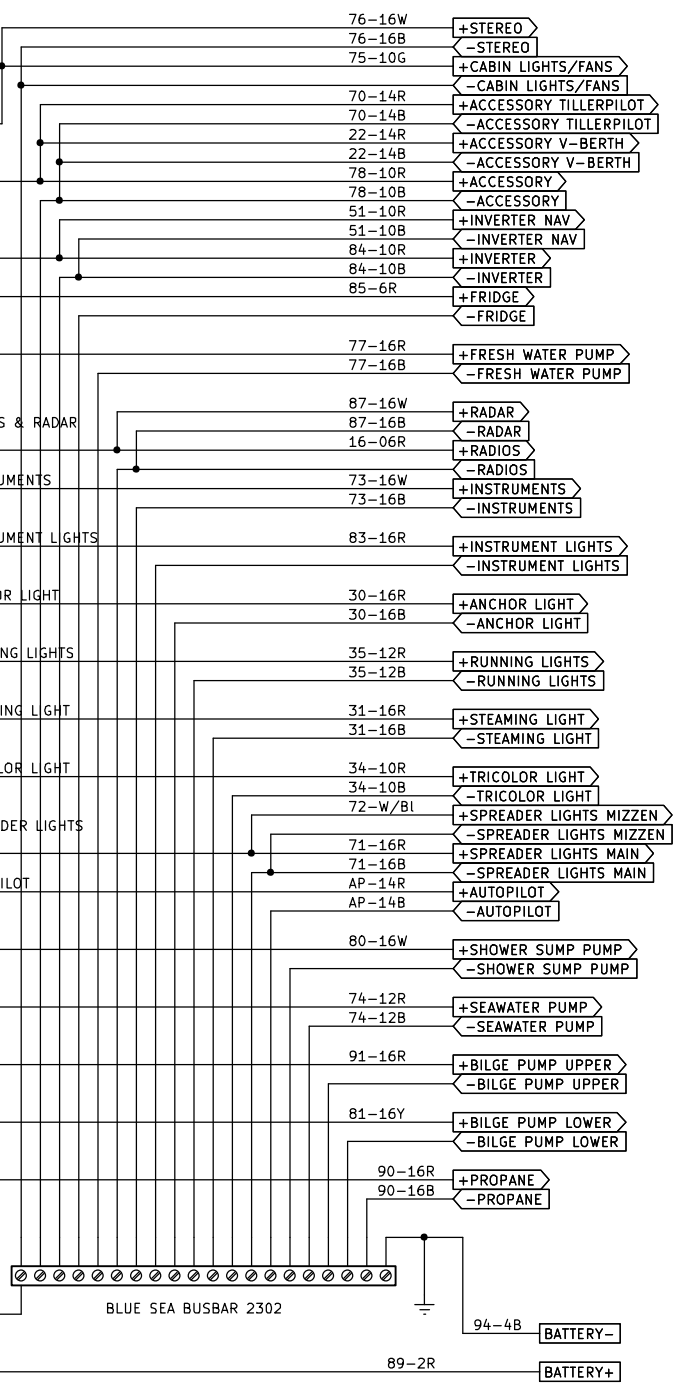
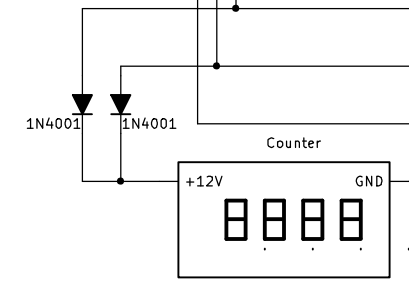
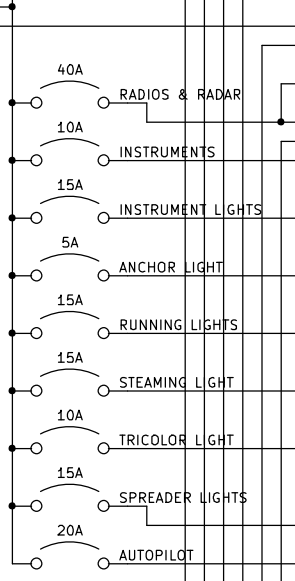
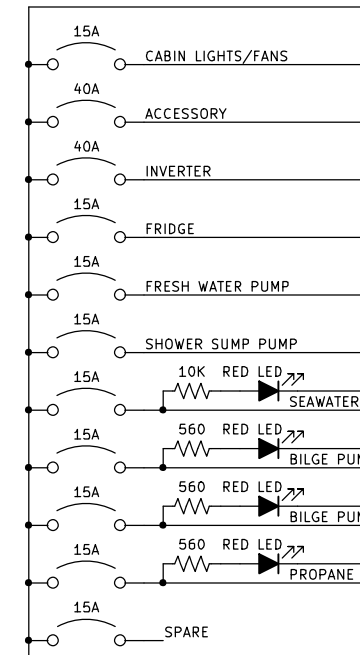
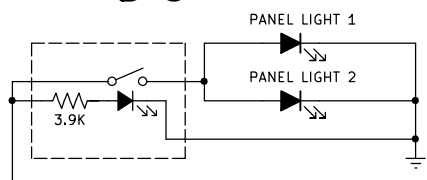
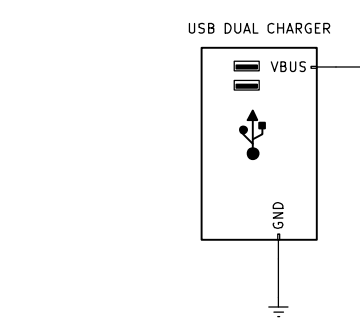
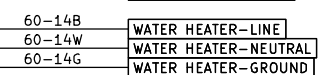
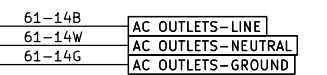
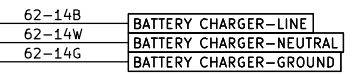
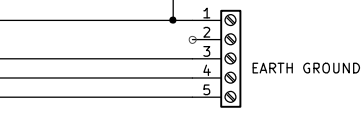
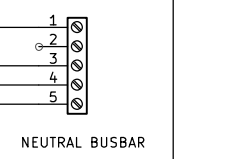
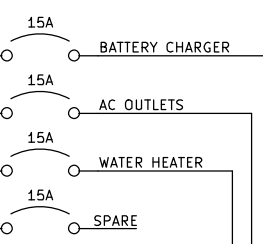
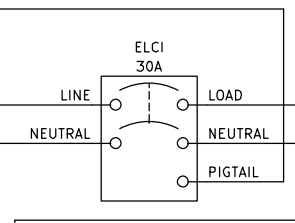
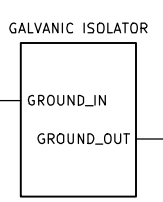
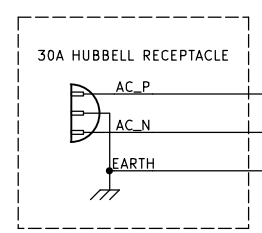
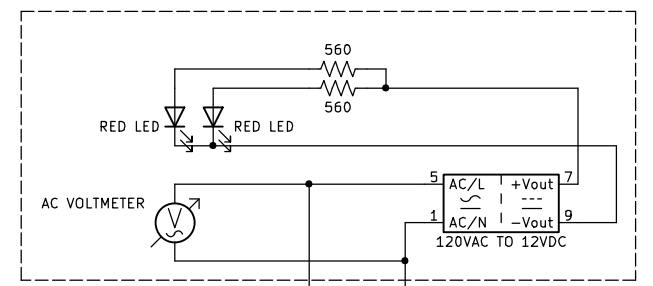

SCOTT ROSENTHAL
 Sheet: /
 File: Willow Electrical Panel.kicad_sch
Title: WILLOW ELECTRICAL PANEL
 Size: B Date: 2025-10-21 Rev:
 KiCad E.D.A. 9.0.5 Id: 1/1