

FIGARO

an ISO9001 company

Technical Information for Carbon Monoxide Sensors

Figaro’s TGS5042 is a battery operable electrochemical sensor which offers several advantages over traditional electrochemical sensors. Its electrolyte is environmentally friendly, it poses no risk of electrolyte leakage, can detect concentrations as high as 1% CO, operates in a range from -5° and +55°C, and it has lower sensitivity to interference gases. With a long life, good long term stability, and high accuracy, this sensor is the ideal choice for CO detectors with digital display. OEM customers will find individual sensors data printed on each sensor in bar code from, enabling users to skip the costly gas calibration process and allowing for individual sensor tracking. TGS5042 utilizes a standard AA battery-sized package.



<i>Specifications</i>	<i>Page</i>
Features.....	2
Applications.....	2
Structure.....	2
Basic Measuring Circuit.....	2
Operating Conditions & Specifications.....	3
Mechanical Strength.....	3
Dimensions.....	3
<i>Operation Principle</i>	4
<i>Basic Sensitivity Characteristics</i>	
Sensitivity to Various Gases.....	5
Temperature and Humidity Dependency.....	5
Gas Response Pattern.....	6
Repeatability.....	6
Influence of Storage.....	6
Normal Operation Test.....	7
Sensitivity Test.....	7
Pressure Dependency.....	8
<i>Reliability</i>	
Interference Gas Test.....	8
Long-Term Stability.....	9
Corrosion Test.....	9
Variable Ambient Temperature Test.....	9
Humidity Test.....	10
Stability Tests.....	11
Sequential Test.....	11
Dust Test.....	12
Water Loss Test.....	12
<i>Marking</i>	12
<i>Cautions</i>	13
<i>Appendix</i>	15

IMPORTANT NOTE: OPERATING CONDITIONS IN WHICH FIGARO SENSORS ARE USED WILL VARY WITH EACH CUSTOMER’S SPECIFIC APPLICATIONS. FIGARO STRONGLY RECOMMENDS CONSULTING OUR TECHNICAL STAFF BEFORE DEPLOYING FIGARO SENSORS IN YOUR APPLICATION AND, IN PARTICULAR, WHEN CUSTOMER’S TARGET GASES ARE NOT LISTED HEREIN. FIGARO CANNOT ASSUME ANY RESPONSIBILITY FOR ANY USE OF ITS SENSORS IN A PRODUCT OR APPLICATION FOR WHICH SENSOR HAS NOT BEEN SPECIFICALLY TESTED BY FIGARO.



TGS5042 is a UL recognized component in accordance with the requirements of UL2034. Please note that component recognition testing has confirmed long term stability in 15ppm of carbon monoxide; other characteristics shown in this brochure have not been confirmed by UL as part of component recognition.

1. Specifications

1-1 Features

- * Battery operable
- * High repeatability/selectivity to carbon monoxide
- * Linear relationship between CO gas concentration and sensor output
- * Simple calibration
- * Long life
- * UL recognized component
- * Meets UL2034, EN50291, and RoHS requirements

1-2 Applications

- * Residential and commercial CO detectors
- * CO monitors for industrial applications
- * Ventilation control for indoor parking garages
- * Fire detection

1-3 Structure

Figure 1 shows the structure of TGS5042. The gas sensing layer is sandwiched between a stainless steel washer (counter electrode) and a stainless steel cap (working electrode), together with gas diffusion control stainless film and backing layers. This assembly is placed in the compartment of the stainless steel can. Water is stored in the bottom compartment and a charcoal filter is installed inside the stainless steel cap.

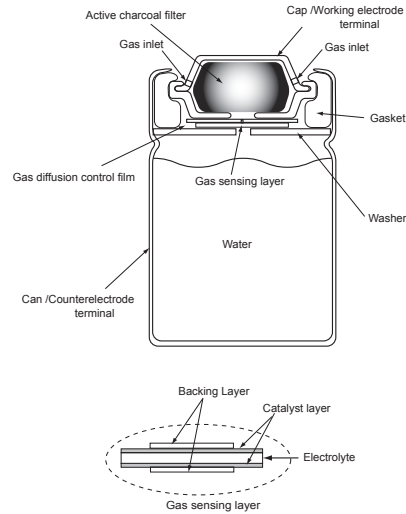

Figure 1 - Sensor structure

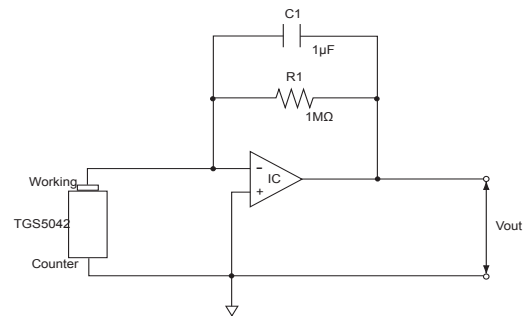

Figure 2 - Basic measuring circuit
(Including equivalent circuit)

1-4 Basic measuring circuit

Figure 2 shows the basic measuring circuit of TGS5042. The sensor generates a minute electric current which is converted into sensor output voltage (V_{out}) by an op-amp/resistor ($R1$) combination.

Figaro recommends the following electrical parts:

- $R1 : 1M\Omega$
- $C1 : 1\mu F$
- IC : AD708

An additional resistor or FET is required to prevent polarization of the sensor when circuit voltage is off.

NOTE: When voltage is applied to the sensor output terminal, the sensor may be damaged. Voltage applied to the sensor should be strictly limited to less than $\pm 10mV$.

1-5 Operating conditions & specifications (Table 1)

Item	Specification
Model number	TGS5042-A00
Target gases	Carbon monoxide
Typical detection range	0 ~ 10,000ppm
Output current in CO	1.2~2.4nA/ppm
Baseline offset (NOTE 1)	$< \pm 10ppm$ equivalent
Operating and storage temperature (NOTE 2,3)	$-5^{\circ}C \sim +55^{\circ}C$
Operating humidity	5 ~ 99%RH (no condensation)
Response time (T_{90})	within 60 seconds
Recommended storage temperature	$0^{\circ}C \sim +35^{\circ}C$
Weight	approx. 12g
Standard test conditions	$20 \pm 2^{\circ}C, 40 \pm 10\%RH$

- NOTE 1:** Sensor output in air under operating conditions
- NOTE 2:** If the water in the reservoir should freeze very rapidly (typically occurs only under artificially created conditions), irreversible change to sensor characteristics would occur. To avoid this risk, the sensor is recommended to be positioned with its cap (working electrode) facing up.
- NOTE 3:** Please contact Figaro for more information if the required temperature range would exceed the specified limits.

Table 1 - Operating conditions and specifications

1-6 Mechanical strength

The sensor shall have no abnormal findings in its structure and shall satisfy the above electrical specifications after the following performance tests:

Withstand force -

withstand force of 10kg (cap from metal can) along a vertical axis

Vibration - frequency--10~500Hz (equiv. to 10G), duration - 6 hours, x-y-z direction

Shock - acceleration-100G, repeat 5 times

All sensor characteristics shown in this brochure represent typical characteristics. Actual characteristics vary from sensor to sensor and from production lot to production lot. The only characteristics warranted are those shown in the Specification.

1-7 Dimensions (see Fig. 3)

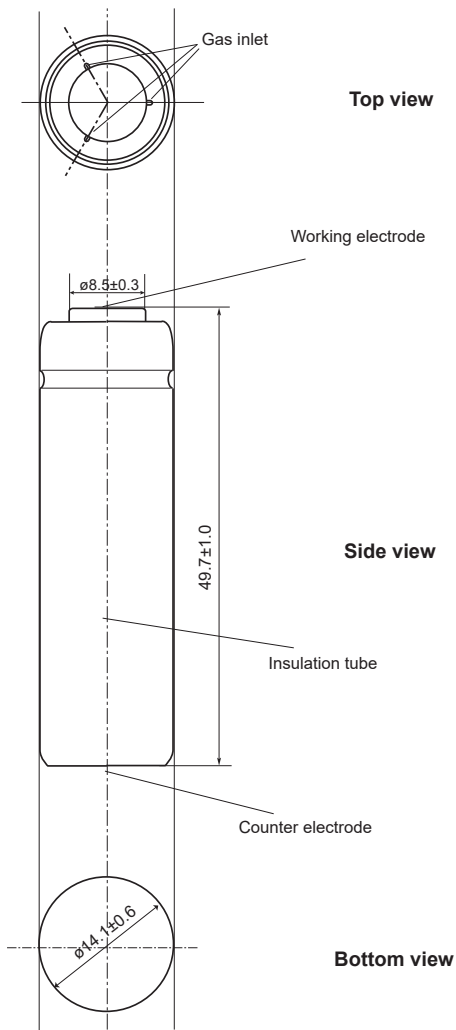

NOTE: The sensor can be supplied with lead pins. Please refer to the *Appendix* for details

Figure 3 - Dimensions

2. Operation Principle

The TGS5042 is a proton conductor carbon monoxide (CO) sensor that utilizes short-circuit current as a sensor signal. When CO mixed with air enters through the gas diffusion control film and reaches the working electrode, protons and electrons are generated as a result of a CO oxidization reaction (see equation 1) as well as cathodic reduction of oxygen (see equation 2). Some of the protons and electrons generated in equation 1 are consumed in this reaction. By creating a short circuit between the working and counter electrodes with external wiring, electrons and protons on the working electrode move to the counter electrode through the external wiring and through the proton conductor respectively. The proton then reacts with oxygen on the counter electrode as shown in equation 3.

A linear relationship exists between the sensor output current and CO concentration (see equation 4). By calibrating the sensor with a known concentration of CO, the output current of the sensor can be used to quantitatively determine CO concentration.

For more details about Operation Principle, please refer to "Operation Principle of Short-circuit Current type Proton Conductor CO Sensor" on our corporate site.

Since, unlike conventional dry batteries, there is no consumption of active materials or of the electrodes, TGS5042 possesses excellent long-term stability for its output signal and enables maintenance-free operation. Furthermore, the sensor's self-generating output current makes it ideal for usage in battery-operated CO detectors.

Working electrode (Anodic reaction)

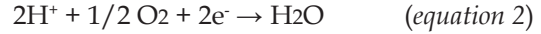

Counter electrode (Cathodic reaction)

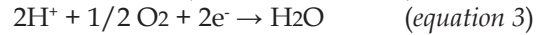

Theoretical output current value

$$I = F \times (A/\sigma) \times D \times C \times n \quad (\text{equation 4})$$

where:

F: Faraday constant

A: Pinhole area of diffusion film

D: Gas diffusion co-efficient

C: Gas concentration

σ : Thickness of diffusion film

n: Number of reaction electrons

Figure 4 - Operation principle

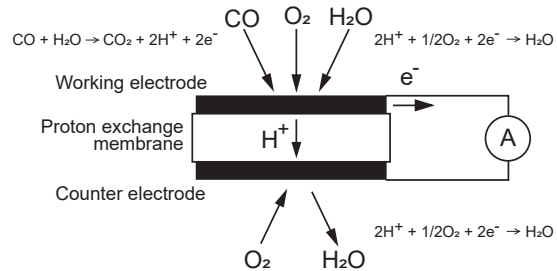

Figure 5 - Schematic diagram of TGS5042 operating principle

3. Basic Sensitivity Characteristics

3-1 Sensitivity to various gases

Figure 6 shows the sensor's sensitivity to various gases. The Y-axis shows output current ($I_{out}/\mu A$) in each gas. The output current is linear to CO concentration, with a deviation of less than $\pm 5\%$ in the range of 0~1000ppm. Cross sensitivity data for other gases than those in Figure 6 are tabulated in Table Y.

Gas		Concentration	CO equivalent
Hydrogen		1000ppm	<350ppm
Methane	Heptane	1000ppm	<30ppm
Butane	IPA		
Ethanol	Freon R22		
HMDS (Si vapor)	Acetone		
Toluene	Cyclohexane		
Trichloroethane	CO ₂	200ppm	<30ppm
Formaldehyde	Ammonia		
Xylene	SO ₂		
Acetic acid	Ethyl acetate		
NO ₂	Ethylene		
Acetylene		200ppm	300ppm

Note: The figures in this table are typical values and should not be used as a basis for cross calibration. Cross sensitivity for various gases may not be linear and should not be scaled. All data based on a 4 minute exposure. For some gases, filter saturation and gas breakthrough may occur if gas is applied for a longer time period.

3-2 Temperature and humidity dependency

Figure 7a shows the temperature dependency of TGS5042 under a constant humidity of 50%RH. The Y-axis shows the ratio of output current in 400ppm of CO at various temperatures (I) to the output current in 400ppm of CO at 20°C/50%RH (I_0). Temperature dependency is based on the difference in the catalytic reaction rate on the electrodes, and it can be simply compensated by utilizing a thermistor. This linear relationship between I/I_0 and CO concentration is constant regardless of CO concentration range, according to the sensor's operating principle.

Figure 7b shows the humidity dependency of TGS5042 under constant temperatures of 20°C and 50°C. The Y-axis shows the ratio of output current in 400ppm of CO at various relative humidities (I) to the output current in 400ppm of CO at 20°C/50%RH (I_0). This data demonstrates that humidity dependency is negligible as temperature varies.

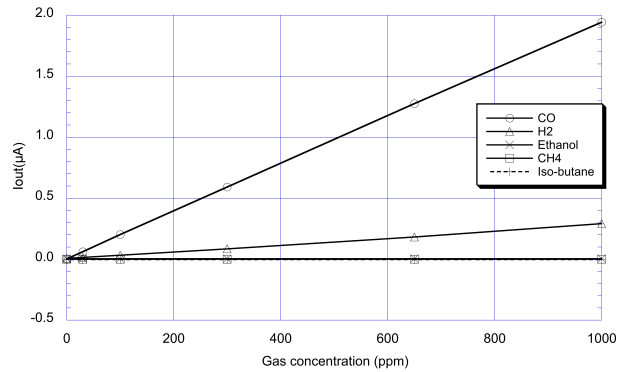

Figure 6 - Sensitivity to various gases

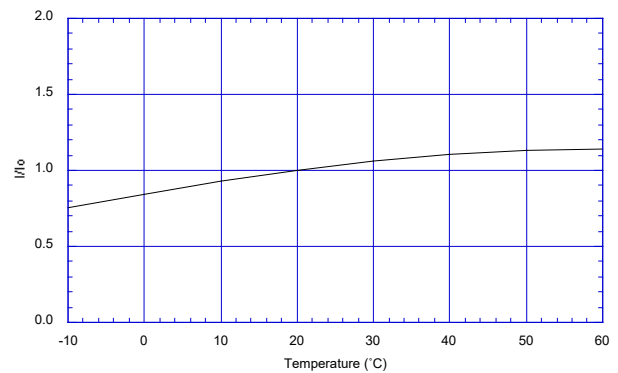

Figure 7a - Temperature dependency at 400ppm CO/50%RH (I_0 =sensor output current at 20°C)

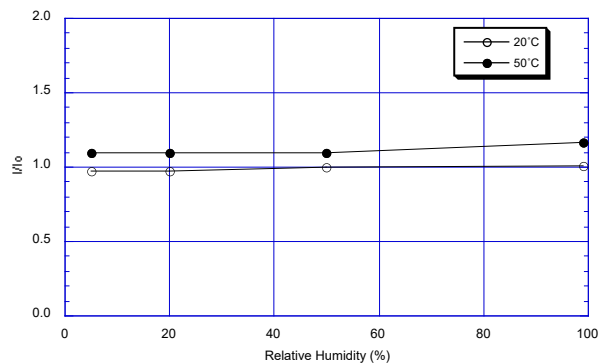

Figure 7b - Humidity dependency at 400ppm CO (I_0 =sensor output current at 50%RH)

3-3 Gas response pattern

Figure 8 shows the gas response pattern of the output signal when the sensor is placed into 30, 70, 150 and 400ppm of CO and then returned to normal air. The response time to 90% of the saturated signal level is within 60 seconds, and the recovery of the signal back to 90% of the base level is within 120 seconds. This data demonstrates that TGS5042 possesses sufficient response speed for meeting UL requirements for CO detectors.

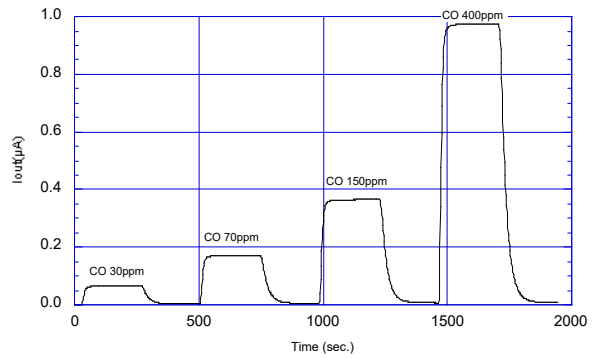

Figure 8 - Response pattern

3-4 Repeatability

Figure 9 shows the pattern of the output signal when the sensor is repeatedly exposed to 400ppm of CO at a constant interval of 240 seconds. The data demonstrates extremely high reproducibility of the output signal, the deviation being less than $\pm 5\%$.

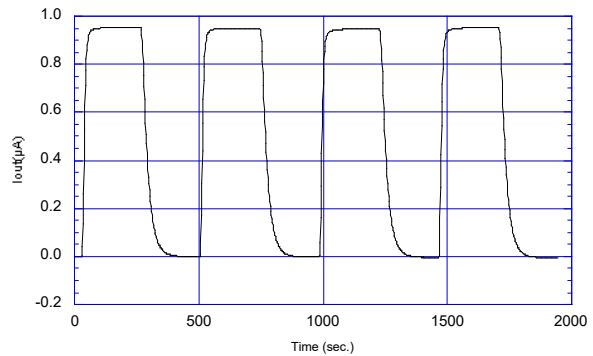

Figure 9 - Repeatability (in 400ppm of CO)

3-5 Influence of storage

Figure 10 shows the initial action of the sensor's output current signal in fresh air. For the purpose of this test, sensors were stored for more than six months under two separate conditions between the working and counter electrodes: in short-circuited condition, and in open-circuited condition. The chart illustrates the behavior of sensor output current for each group just after installation into the operating circuit. The output current signal of sensors stored in a short-circuited condition reaches its saturated level quickly, while those stored with an open-circuit exhibit much slower behavior.

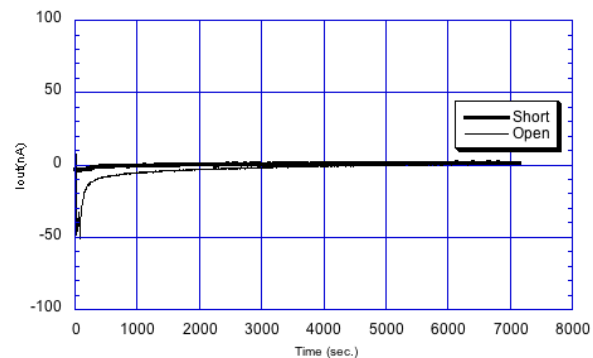

Figure 10 - Influence of storage (in fresh air)

Since sensors are shipped in an open-circuit condition, stabilization time of one hour (typical) is recommended after mounting on a PCB that includes an anti-polarization circuit (see Item 2-4 in Application Notes for TGS5xxx Series). If no antipolarization circuit is used, it is necessary to wait for about one hour after powering the circuit. One hour of powering is required, regardless of when the sensor is placed into the detector circuit.

3-6 Normal operation test

Figure 11a shows the result of the “Normal Operation Test” required by UL2034, Sec. 35.3 where the sensor is exposed to 600ppm of CO for 12 hours at 20°C/40%RH. Stable output current signal can be seen throughout the exposure.

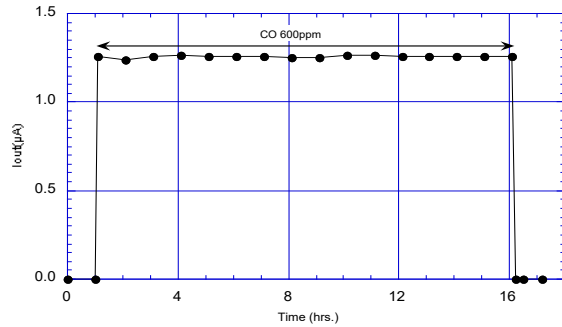

Figure 11a - Normal operation test
(CO 600±30ppm for 12 hours at 20°C/40%RH)

In addition, Figure 11b shows the CO sensitivity characteristics of the sensor before, during, and after the Normal Operation Test, demonstrating that TGS5042 is hardly influenced by exposure to high concentrations of CO.

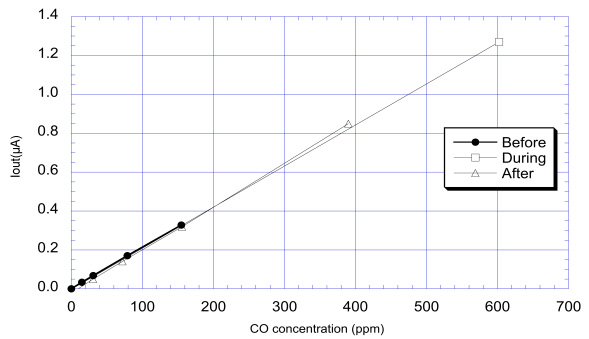

Figure 11b - Normal operation test (20°C/40%RH)

3-7 Sensitivity test

Figure 12a shows the results of the “Sensitivity Test” as required by UL2034, Sec. 38. Under this test, the sensor was exposed to 30, 70, 150 and 400ppm of CO at 20°C/40%RH. The period of exposure was varied by concentration, corresponding with the maximum time in which a CO detector should generate an alarm for the subject concentration. Throughout the test exposures, TGS5042 displayed a reasonable and stable output current signal.

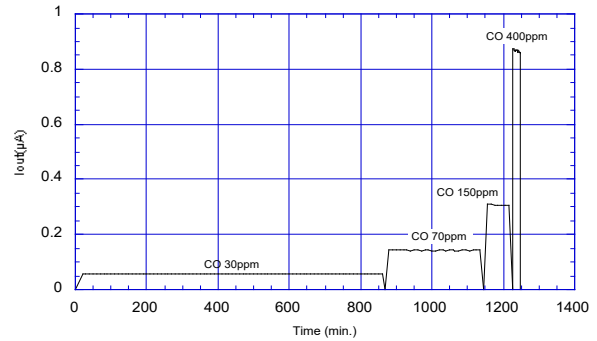

Figure 12a - Sensitivity test (20°C/40%RH)

In addition, Figure 12b indicates the CO sensitivity characteristics of the sensor before, during, and after the Sensitivity Test, demonstrating the excellent reproducibility of TGS5042's CO sensitivity characteristics.

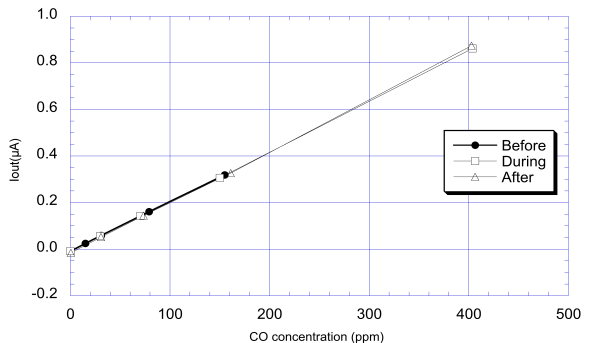

Fig. 12b - Sensitivity test (20°C/40%RH)

3-8 Pressure dependency

Figure 13 shows an example of the pressure dependency of TGS5042. The Y-axis shows the ratio of output current in 300ppm of CO at various pressures (I) to the output current in 300ppm of CO at 101.3kPa (I₀). The sensor performance is not affected by ambient air pressure changes. But its output current may appear to have pressure dependence since CO molar concentration in air changes with changing ambient pressure.

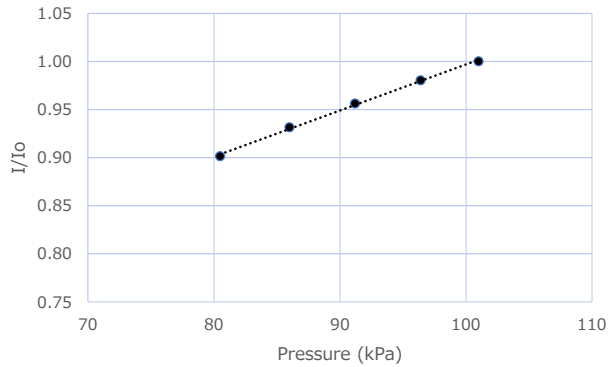

Fig. 13 - Pressure dependency

4. Reliability

Tests conducted in this section demonstrate that TGS5042 can meet the requirements of various testing standards without incurring adverse long term effects from such tests.

4-1 Interference gas test

Figure 14a shows the results of testing the TGS5042 sensor for durability against various interference gases as specified by UL2034, Sec. 39. The test was conducted by exposing the sensor to each gas shown in Figure 14a (starting with CO 30ppm) for two hours, then removing the sensor to fresh air for just one hour, and followed by inserting the sensor into the next gas. This procedure was repeated for the full range of gases shown in Figure 14a.

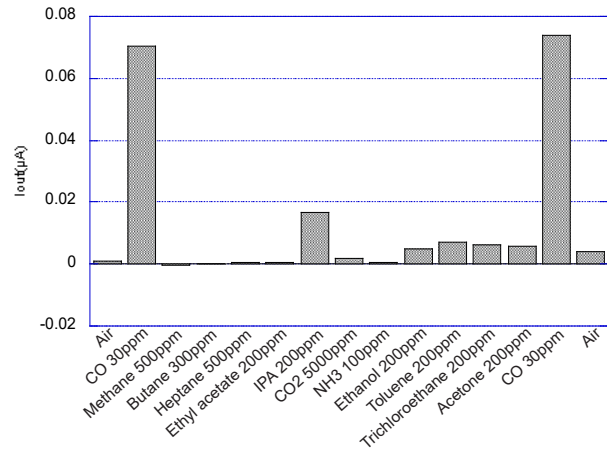

Figure 14a - Interference gas test (20°C/40%RH)

Because the sensor is exposed to each of the test gases consecutively, to some small extent the effect of the previous test gas may affect subsequent tests for a short period. However, despite the short-term effects of such gases remaining after exposure, the sensor still shows significantly less sensitivity to each test gas when compared to 30ppm of CO, and CO sensitivity remains unaffected.

In addition, Figure 14b shows the CO sensitivity characteristics of the sensor before and after this test, further demonstrating the excellent reproducibility of the CO sensitivity characteristics of TGS5042, demonstrating its durability against the interference gases listed in the requirements of UL2034, Sec. 39.

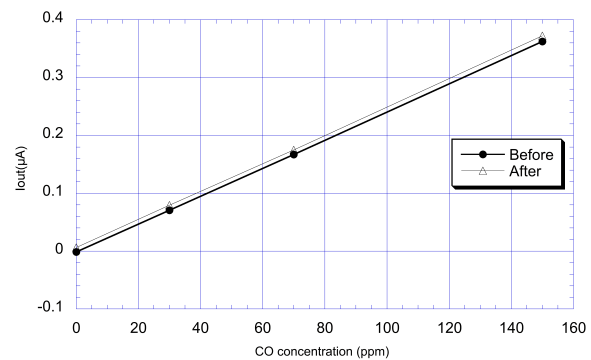

Figure 14b - Interference gas test (20°C/40%RH)

4-2 Long-term stability

Figure 15 shows long-term stability data for TGS5042. Test samples were stored in natural clean air under a short-circuit condition and measured at various intervals as dictated by the standard test conditions of UL2034, Sec. 38. The Y-axis shows the ratio of output current in 300ppm of CO at any point in time (I) over output current in 300ppm of CO on the first day of the test (I₀). This chart demonstrates very stable characteristics for more than 9 years, though sensor output tends to decrease slightly over time.

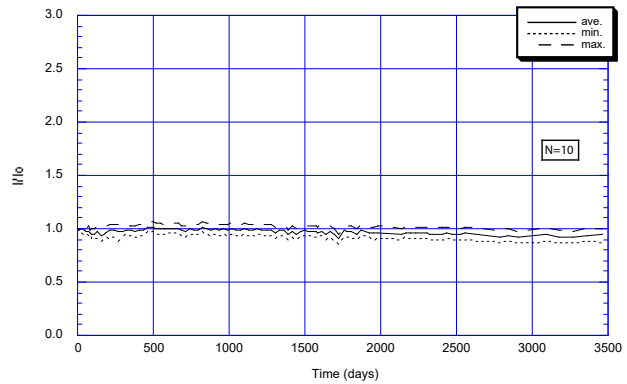

Figure 15 - Long term stability

4-3 Corrosion test

To demonstrate the durability of TGS5042 against corrosion, samples were subjected to test conditions called for by UL2034, Sec.58-Corrosion Test. Over a three-week period, a mixture of 100ppb of H₂S, 20ppb of Cl₂, and 200ppb of NO₂ was supplied to the sensors at a rate sufficient to achieve an air exchange rate of five times per hour. Figure 16 shows the CO sensitivity characteristics before and after exposure in the above conditions, demonstrating that TGS5042 is hardly influenced by such corrosive gases. In addition, the sensor's stainless steel housing did not show any sign of corrosion as a result of this test.

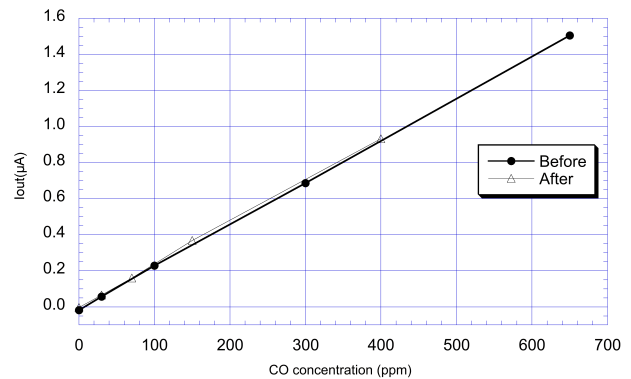

Figure 16 - Durability against corrosion

4-4 Variable ambient temperature test

To demonstrate the ability of TGS5042 to withstand the effects of high and low temperature, the "Variable Ambient Temperature Test" of UL2034, Sec. 45 was conducted.

(1) Operation in high and low temperature test

Figure 17a shows the results for the "Operation in High and Low Temperature Test" of UL2034, Sec. 45.1. The sensor was exposed to environments of 0°C/15%RH and 49°C/40%RH for at least three hours each, with measurements taken before and during the exposure in accordance with the test conditions of UL2034, Sec. 38. By plotting the output current values from these test measurements atop the data taken prior to this test at a constant 50%RH (representing standard temperature dependency), it can be seen that the test data are still in line with data taken at a constant RH. The conclusion which can be drawn is that, regardless of exposure to extremes of temperature and humidity, the sensor's output is not affected by humidity. As a result, TGS5042 can meet the requirements of UL2034, Sec. 45.1 by utilizing a simple temperature compensation method.

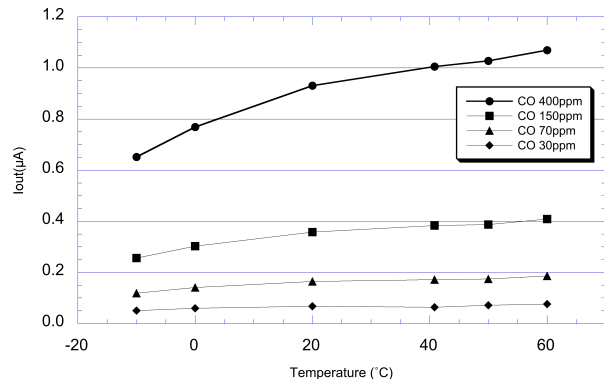

Figure 17a - Operation in high and low temperature (all data at 50%RH except Sec. 45.1 test points)

(2) Effect of shipping and storage

To verify the effects of shipping and storage, the sensor was tested under the conditions of UL2034, Sec. 45.2. Test samples in a short-circuited condition were subjected to 70°C for 24 hours, allowed to cool to room temperature for 1 hour, subjected to -40°C for 3 hours, and then allowed to warm up to room temperature for 3 hours. Figure 17b shows the CO sensitivity characteristics before and after the test, demonstrating that TGS5042 meets the requirement of UL2034, Sec. 45.2.

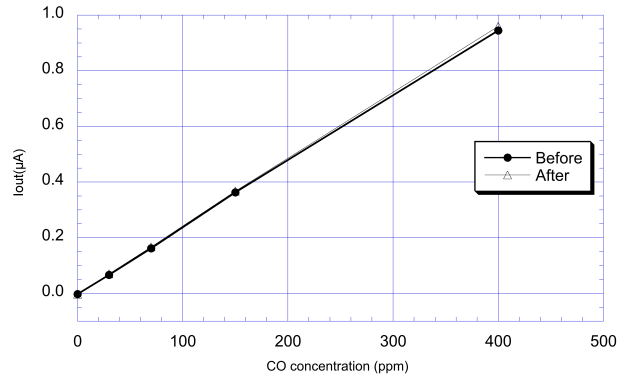

Figure 17b - Effects of shipping and storage

4-5 Humidity test

Figure 18a shows the results of testing the sensor under UL2034, Sec. 46A. The sensor was exposed in an atmosphere of 52±3°C/95±4%RH for a period of 168 hours, returned to normal air for 2 days, then followed by 168 hours exposure at 22±3°C/10±3%RH. CO sensitivity measurements were taken during exposure to high and low humidity conditions. Measurements were taken at 20°C/50%RH before and after exposure to high and low humidity conditions. The data demonstrates the stable characteristics in both low and high humidity conditions.

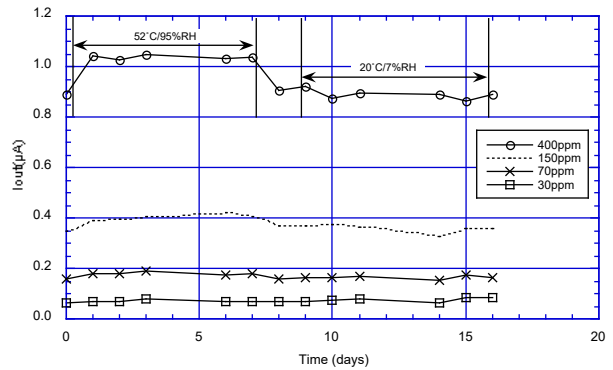

Figure 18a - Humidity test

Figure 18b shows data taken prior to the above test at a constant relative humidity of 50%. These curves represent the typical temperature dependency of the sensor. When plotting measurements taken at the environmental extremes specified on UL2034, Sec. 46A (52±3°C/95±4%RH and 22±3°C/10±3%RH) onto the temperature dependency curves, it can be seen that measurements taken at these extreme conditions still fall in line with the temperature dependency curve derived prior to testing. The conclusion which can be drawn is that, regardless of exposure to extremes of temperature and humidity, the sensor's output is not affected by humidity. As a result, TGS5042 can meet the requirements of UL2034, Sec. 46A by utilizing a simple temperature compensation method.

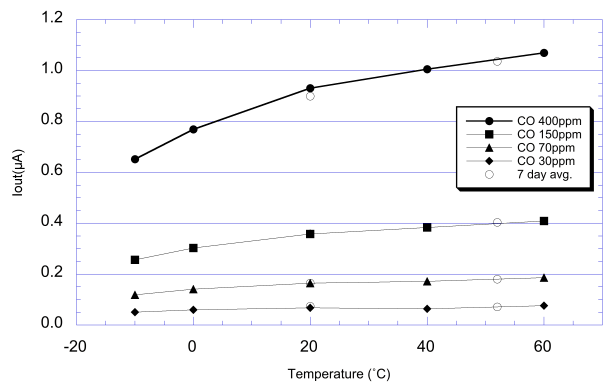

Figure 18b - Humidity test
(all data at 50%RH except Sec. 46A test points)

4-6 Stability test

(1) False alarm test

To show the sensor's behavior under continuous low level exposure to CO, samples were tested against the procedure detailed in UL2034, Sec. 41.1(c)-Stability Test. Test samples were exposed to 30ppm of CO continuously for a period of 30 days under standard circuit conditions. Figure 19 shows the CO sensitivity characteristics before and after the exposure test, demonstrating that detectors using TGS5042 will not give a false alarm as a result of continuous low level CO exposure.

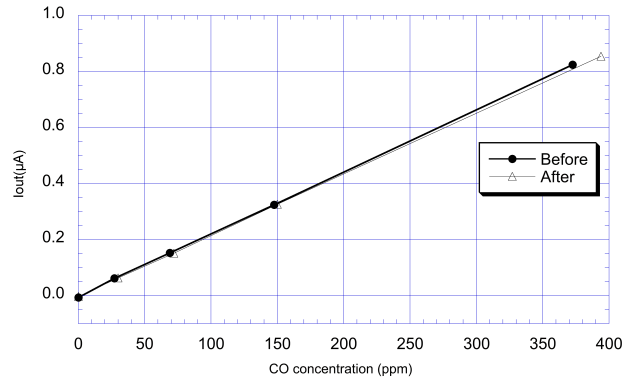

Figure 19 - False alarm test

(2) Temperature cycle test

In accordance with UL2034, Sec. 41.1(e)-Stability Test, test samples were exposed to ten cycles (<1 hour and >15 minutes) of temperature from 0°C/100%RH to 49°C/40%RH. Figure 20 shows CO sensitivity characteristics before and after the cycle test, demonstrating that TGS5042 is hardly influenced by the extreme conditions of the temperature cycle test.

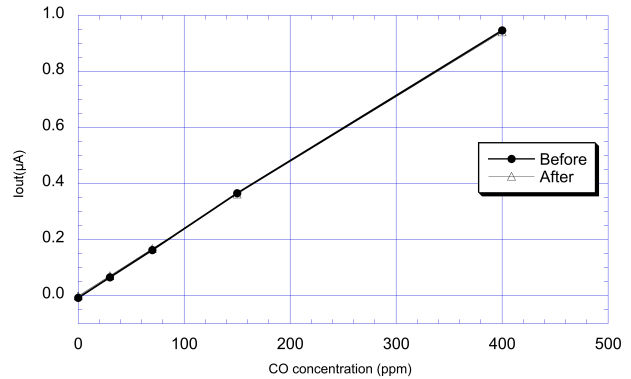

Figure 20 - Temperature cycle test

4-7 Sequential test

In UL2034, Sec. 41.3, a single lot of sample detectors are to be subjected to the following sequence of tests: Section 38, Section 41.1, Section 39, Section 45, and Section 46A. While TGS5042 meets the requirements of each of these test individually (*as shown elsewhere in this brochure*), this test is designed to demonstrate the sensor's ability to withstand all of these test when conducted in sequence. Figure 21 shows the results of sequentially testing the same lot of sensors. The good stability of the sensor's output signal indicates that TGS5042 can satisfy the requirements of UL2034, Sec. 41.3-Sequential Test.

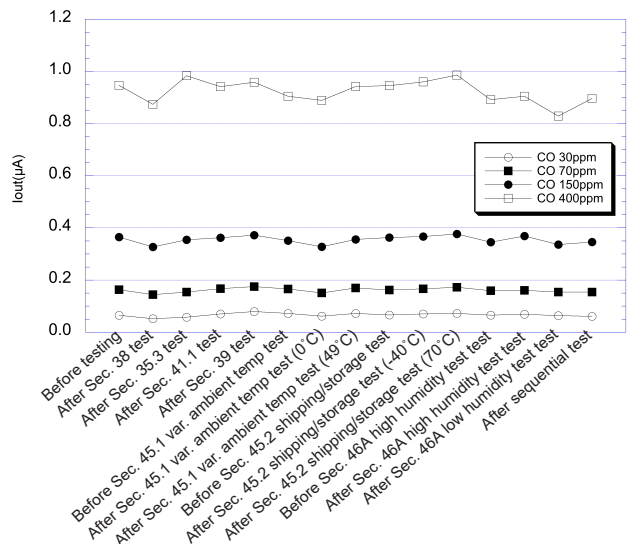

Figure 21 - Sequential test

4-8 Dust test

To judge the effect of dust contamination on TGS5042, approximately 2 ounces (0.06 kg) of cement dust, capable of passing through a 200 mesh screen, was circulated for 1 hour by means of a blower, enveloping the sensor in the test chamber. Air flow was maintained at an air velocity of approximately 50 fpm (0.25 m/s) at 20°C/40%RH.

Figure 22 shows the sensor's CO sensitivity characteristics before and after the dust exposure test. This data demonstrates that the dust test of UL2034, Sec. 53 has a negligible effect on CO sensitivity.

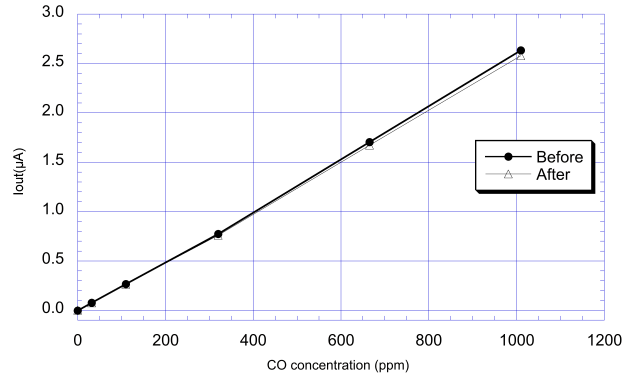

Figure 22 - Dust test

4-9 Water loss test

For evaluating the life expectancy of TGS5042 from the viewpoint of its water reservoir (which prevents the electrolyte from drying up), the weight loss of TGS5042 was periodically measured when stored at 70°C. Figure 23 demonstrates that the sensor's weight decreased linearly with time due to evaporation of the water. The rate of water loss under various temperature was related with the water vapor pressure at each temperature. According to calculations based on this rate of water loss and the differences in water vapor pressure in 20°C and 70°C, the water (>4.5g initially) will last more than 10 years under natural residential conditions such as 20°C/40%RH.

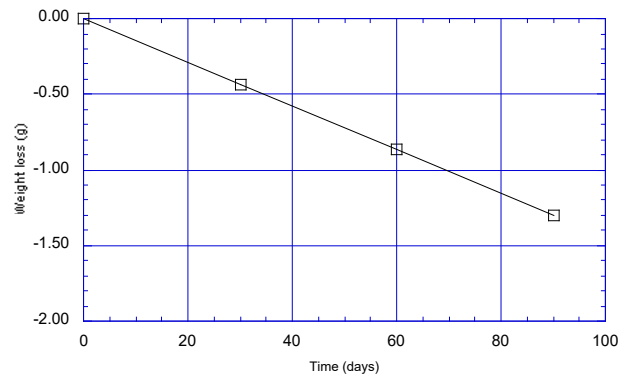

Figure 23 - Water loss test

5. Marking

The TGS5042 comes with a sticker attached to the sensor housing which contains important information. The one dimensional bar code indicates the sensor's sensitivity (slope) in numeric value as determined by measuring the sensor's output in 300ppm of CO:

$$xxxx = x.xxx \text{ nA/ppm}$$

In user readable format, the sensor's sensitivity per ppm (nA) is printed below the one dimensional bar code and the sensor's Lot Number is printed to the left of the sensitivity data. Please note that three decimal places should be added to the sensitivity reading (e.g. 1827 should be read as 1.827 nA/ppm).

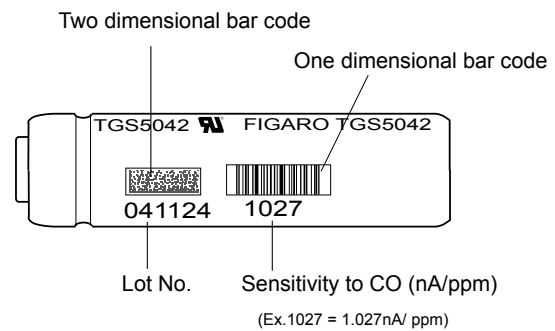

Figure 24 - TGS5042 markings
(NOTE: UL Mark may appear on shrink tube)

6. Cautions

6-1 Situations which **must** be avoided

1) Disassembling the sensor

Under no circumstances should the sensor be disassembled, nor should the sensor can and/or cap be deformed.

2) Contamination by alkaline metals

Sensor characteristics may be significantly changed when the sensor is contaminated by alkaline metals, especially

salt water spray.

3) *Exposure to high concentration of basic (non-acidic) gases*

Sensor characteristics may be irreversibly changed by exposure to high concentrations of basic gases such as ammonia. Avoid long term exposure to or use of packing materials that may generate basic gases.

4) *Exposure to certain VOCs*

Avoid prolonged exposure to certain VOCs such as styrene (commonly used in blister packs and packing trays) and α -pinene (found in some kinds of printing inks). Off-gassing from such VOCs may cause irreversible changes to sensor characteristics. Avoid packing the sensor or products incorporating the sensor in a tightly closed container in which such VOC gases may be present. It is strongly recommended to conduct a test to see if there would be any adverse influence by packing materials on sensor characteristics. If the sensor is excessively exposed to other organic vapors such as alcohols or acetone, these gases may cause temporary change of cross sensitivity characteristics.

5) *High temperature exposure*

At temperatures of 80°C or higher, the sensing membrane may deteriorate, resulting in irreversible change of sensor characteristics.

6) *Contact with water*

Sensor characteristics may be changed due to soaking or splashing the sensor with water.

7) *Application of excessive voltage*

If higher than specified voltage is applied to the sensor, breakage may occur or sensor characteristics may drift, even if no physical damage or breakage occurs. Do not use the sensor once excessive voltage is applied.

6-2 *Situations to avoid whenever possible*

1) *Exposure to silicone vapors*

Avoid exposure of sensor where silicone adhesives, hair grooming materials, or silicone rubber/putty may be present. Silicone vapors may cause clogging of the gas diffusion route.

2) *Dew condensation*

If severe dew condensation occurs for a long period inside of the sensor or on the sensor surface, it may cause clogging of gas diffusion route or deterioration of the sensing membrane. Mild dew condensation which occurs in normal indoor air would not cause any significant damage.

3) *Storage in sealed container*

Do not keep the sensor in a sealed containers such as sealed bag. Due to ambient temperature change, dew condensation may occur inside the sensor if the sensor is stored in this manner.

4) *Freezing*

When subjected to temperatures below 0°C, it is possible that the water in the reservoir may freeze. Since water volume will expand when freezing, the sensor can may undergo some deformation. Care should be taken in the design of the detector to ensure that the sensor is not placed too close to other components or the circuit pattern on a PCB, as such deformation may cause the sensor to come in contact with these items. In addition, if the freezing process were to occur very rapidly, the sensor will undergo irreversible change in its characteristics. To avoid this risk, it is recommended that the sensor be positioned with the cap (working electrode) facing up (for more information, refer to *Item 4-1 Position Dependency of the Sensor* in the document *Application Notes for TGS5xxx Series*).

5) *Exposure to hydrogen sulfide or sulfuric acid gas*

If the sensor is exposed to hydrogen sulfide or sulfuric acid gas, sensor components such as the gas diffusion film, can, and cap may be corroded, resulting in the sensor damage.

6) *Vibration and shock*

Vibration and shock may cause an open or short circuit inside the sensor.

7) *Dust and oil mist*

Extremely high concentrations of dust or oil mist may cause clogging of the sensor's internal structure. When such conditions are expected to be encountered, installation of an external air filter is recommended.

8) *Flux for soldering*

Manual soldering is recommended since high concentrations of flux may affect sensor characteristics when the sensor is soldered by wave soldering. When wave soldering is used, a test should be conducted before production starts to see if there would be any influence to sensor characteristics. Please refer to *Item 7-3 of Application Notes for TGS5xxx Series* for advice on manual soldering conditions.

6-3 *Additional cautions for installation*

This sensor requires the existence of oxygen in the operating environment to function properly and to exhibit the characteristics described in this brochure. The sensor will not operate properly in a zero oxygen environment.

Figaro USA Inc. and the manufacturer, Figaro Engineering Inc. (together referred to as Figaro) reserve the right to make changes without notice to any products herein to improve reliability, functioning or design. Information contained in this document is believed to be reliable. However, Figaro does not assume any liability arising out of the application or use of any product or circuit described herein; neither does it convey any license under its patent rights, nor the rights of others.

Figaro's products are not authorized for use as critical components in life support applications wherein a failure or malfunction of the products may result in injury or threat to life.

Before purchasing this product, please read the Warranty Statements shown in our webpage by scanning this QR code.



https://www.figaro.co.jp/en/pdf/Limited_Warranty_en.pdf

FIGARO ENGINEERING INC.
1-5-11 Senba-nishi
Mino, Osaka 562-8505 JAPAN
Phone: (81)-727-28-2045
URL: www.figaro.co.jp/en/

APPENDIX

TGS5042-A00 Lead Configurations

Leads are connected to sensor electrodes when the sensors are shipped.

Stainless steel (SUS) pin version (Fig. 25)

The solid SUS pins of the -A00 version enable the sensor to be more easily mounted and/or directly soldered onto a PCB.

Mechanical strength:

Withstand force - 6kg along a vertical axis (lead from metal can)

Vibration - frequency--10~500Hz (equiv. to 10G)
 duration--6 hours
 direction--x - y - z

Shock - acceleration of 100G, repeat 5 times

NOTE: When the sensor is shipped, the working electrode and counter electrode are not connected (i.e. open-circuited). To obtain stable sensor output, the sensor should be short-circuited by connecting to a measuring circuit. Figaro's tests have shown that one hour should be enough to stabilize sensor output after 6 months of open-circuit storage in fresh air. Nevertheless, the period to reset sensor polarization depends on storage conditions which includes amount of gases, temperature and humidity, storage period, and customer's circuit. As a result, Figaro recommends measuring the required stabilization period of sensor output in air at the customer's actual production process.

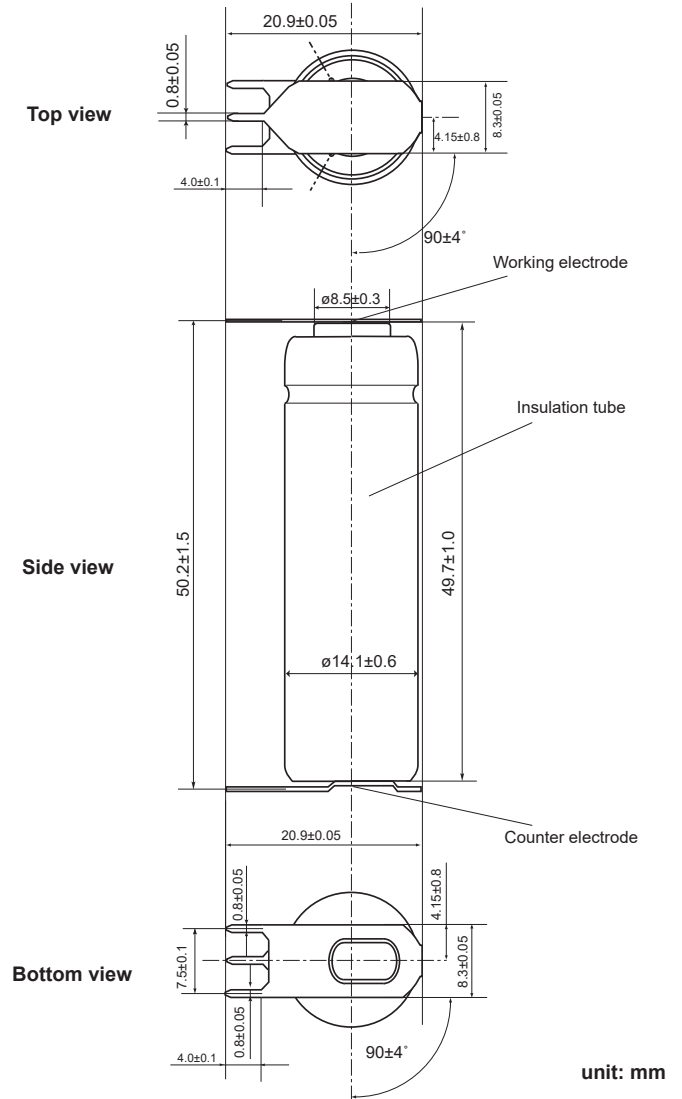

Figure 25 - TGS5042 Dimensions (lead configuration)